

ETQP Series Inductor Product Guide

Metal Composite Type Power Choke Coils

AEC-Q200 Compliant For
Automotive & Industrial Use
In Harsh Environments

- Vibration Resistance of 10G ~ 30G (5Hz – 2kHz)
- Maximum Operating Temperature of 160°C
- Up to 40% Smaller
- Thermal Shock -40 ~+150°C
- Metal Composite Core with Magnetic Shielding
- Non-Hard Saturation



INDEX

Introduction	3
Applications	3
Features and Benefits	
High Current, High Heat Resistance and Excellent Thermal Stability	4
Unique Terminal Structure and Mechanical Robustness	5
Low Leakage Flux	5
AEC-Q200 Compliant for Use in Harsh Environments	6
Facilitates Smaller and Lighter Designs	6
Acoustic Noise Reduction	7
Excellent Withstanding Voltage Characteristics	7
Comparison	
Panasonic's ETQP Series Vs. Alternative Products	8
Explanation of Part Numbers	
Panasonic's ETQP Series Part Number Breakdown	9
Selection Guide	
Panasonic's ETQP Series Selection Guide	10

Introduction

Panasonic's ETQP Series Metal Composite Type Power Choke Coils are suited for filter, step-down and step-up circuits for DC/DC converters. They are AEC-Q200 Compliant offering reliability when exposed to high temperatures along with a high resistance to vibration.

DC / DC Converter Application Example

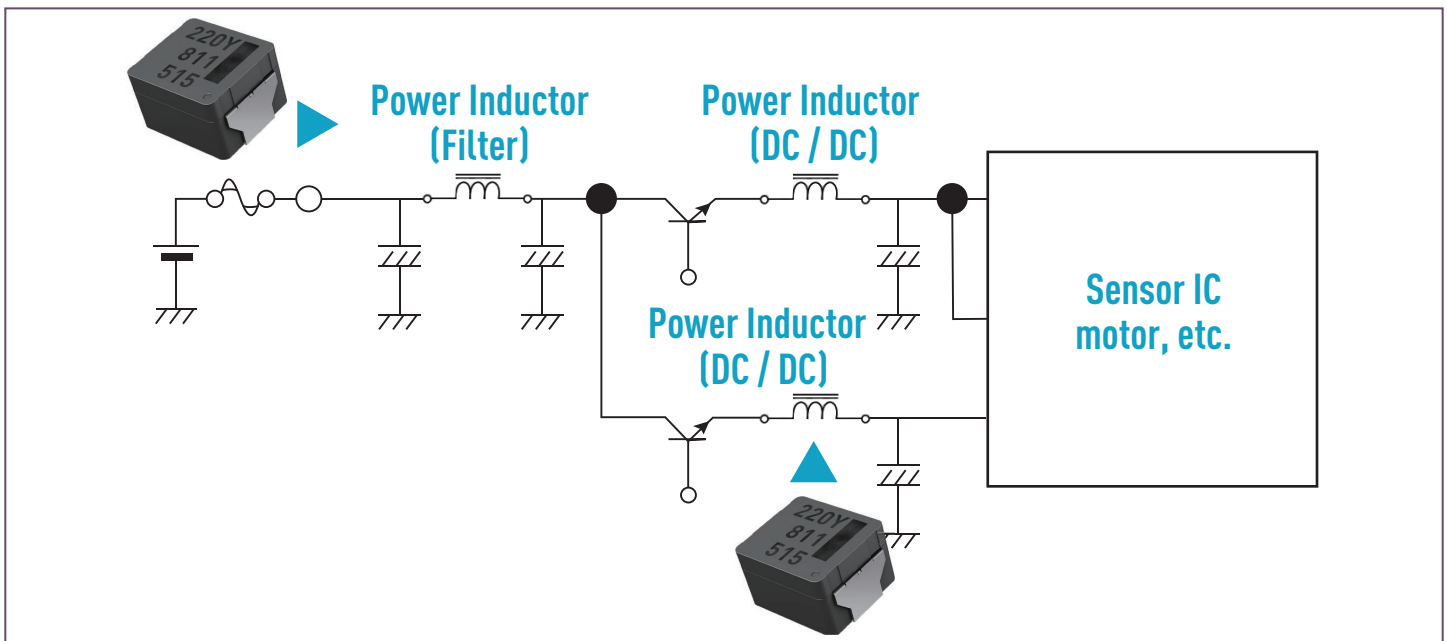

Applications

Circuit

- Noise Filter For Drive Circuits
- DC/DC Converter
- Voltage Regulator
- Buck/Boost Converters

Automotive

- HEV/EV
- Engine ECU
- ADAS
- Power Train

Industrial

- Automation
- Server
- LED Driver
- Power Supply Module

High Current, High Heat Resistance and Excellent Thermal Stability

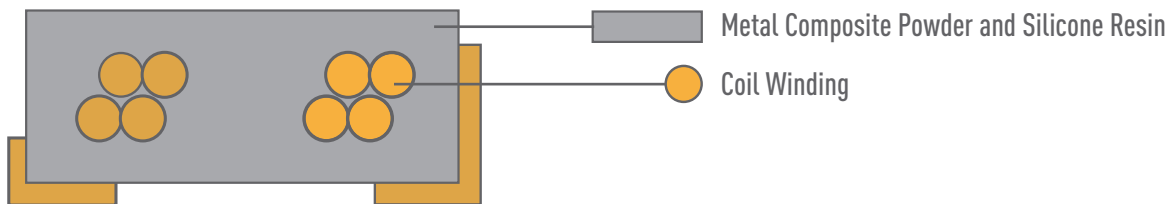

Cross-section view of an ETQPM Power Choke Coil.

- The ETQP Power Inductor consists of metal powder, silicone resin and coil winding. The magnetic material, which is created from Fe-based powder, enables high current, high heat resistance and excellent thermal stability.
- Excellent magnetic saturation characteristics (i.e. Ferrite core = 0.4T vs. Metal Composite Type=above 1.5T) make it difficult to magnetically saturate, resulting in good inductance vs. current performance without substantial drop off.
- By using a high temperature capable resin material, an operating temperature up to 160°C is achievable.
- *Low Profile Series 155°C
- *High Performance Series 160°C

* 180°C under Special Conditions

Frequency Characteristics of AC Resistance

Size : 7 x 7 mm

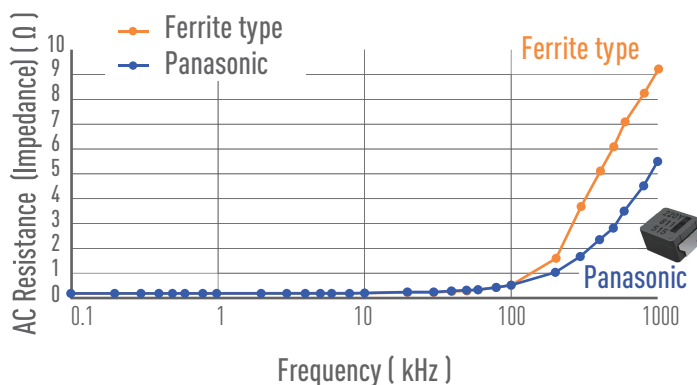

The metal composite molded structure has a distributed gap rather than a discrete gap resulting in low AC resistance (impedance) at higher frequencies.

Effect of DC Bias Current on Inductance

Size : 7 x 7 mm

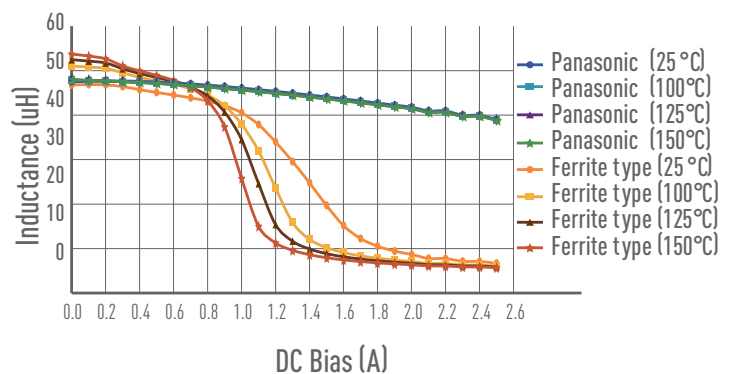

The ETQP Inductor allows for large currents. The inductance levels do not drop significantly as the current increases regardless of the temperature.

Comparison of Panasonic vs. Ferrite Type (At The Same Inductance (Current) Capability)

Manufacturer	Panasonic Metal Composite	Ferrite (Alternative Product)
Series	M0645	Ferrite Type
Size (mm)	6.5 × 6.0	7.4 × 6.9
Height (mm)	4.5 max	4.7 max
Volume (mm) ³	187	240
Core Material	Metal Composite	Ferrite
L1 (uH) at 100kHz	47.0 (0.8A)	47.0 (0.7A)
ISAT (A) at 125°C , L-10%	1.3	0.7
DCR (mΩ)	210	158
Performance Index Per Volume	100%	60%
Max Operating Temperature	160°C	125°C

Achieved 22% downsizing

Temperature condition 125°C

Unique Terminal Structure

The copper wire of the internal coil is brought out directly to the terminal mounting part to ensure the reliability of mounting to the PCB. Other products make the connection inside the Metal Composite, thus it is hard to verify the connection condition and long-term reliability issues may occur with environmental stresses.

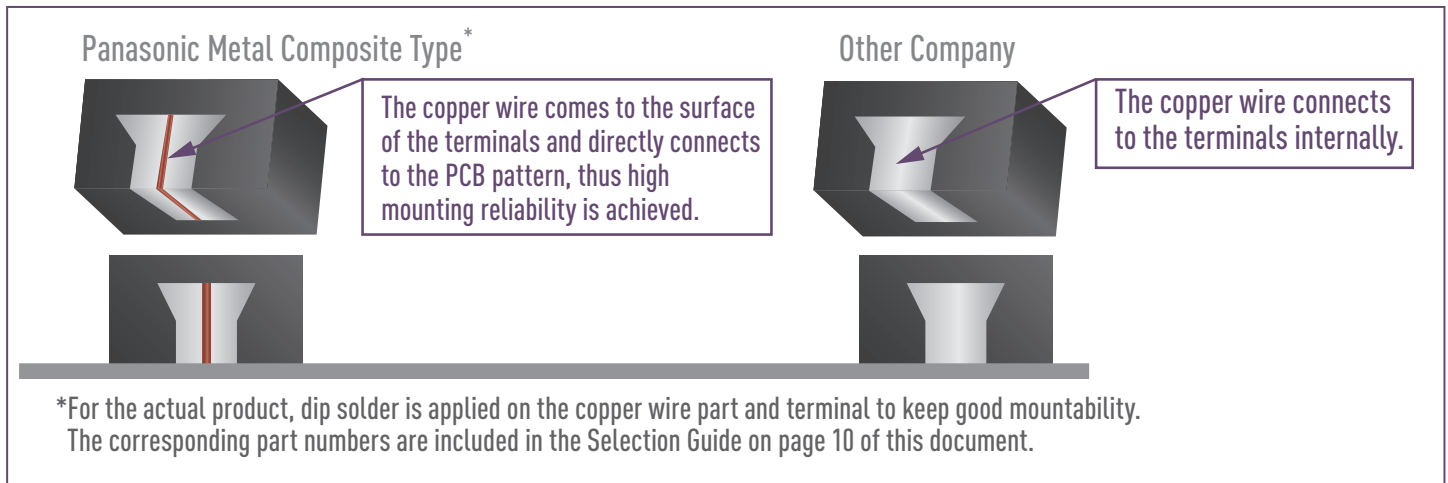

Low Leakage Flux

The integrated molded and magnetic shielded structure of the Metal Composite Type with its distributed gap has low leakage flux from the core resulting in noise and interference reduction, facilitating high density layouts.

AEC-Q200 Compliant For Use In Harsh Environments

Through the previously mentioned improvements, the ETQP Series product provides 150°C temperature and excellent vibration resistance characteristics.

Reliability Results for AEC-Q200 Compliance

Item	Condition	Time	Remark
Thermal Shock	-40 ~ +150°C (Each for 10 minutes)	2000cycles	<ul style="list-style-type: none"> Inductance is ±10% from initial value DCR is ±10% from initial value Insulation resistance is above 10KΩ Nothing abnormal on appearance and structures No open wire or mechanical damage
Vibration Resistance	10G ~ 30G (5Hz - 2kHz)	XYZ (Each for 2 hours)	
Heat Resistance	150°C	2000 hours	
High Temperature Lifetime	150°C (Rated current applied)		
Anti-Humidity	85°C, 85%RH	2000 hours	
Anti-Humidity Lifetime Test	85°C, 85%RH (Rated current applied)		
Low Temperature Test	-40°C	2000 hours	

Facilitates Smaller And Lighter Designs

Panasonic Metal Composite Core Types facilitate smaller designs compared with Ferrite Type Choke Coils. Around 20-40% down in size and 5-25% down in weight.

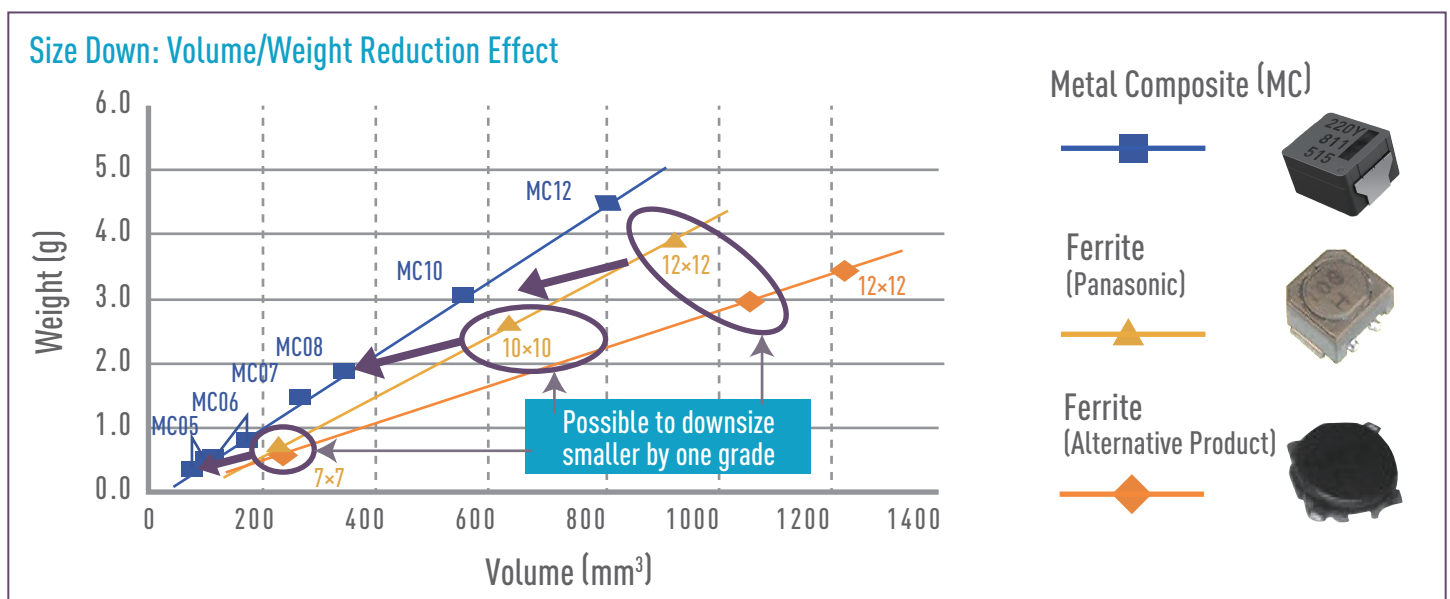

Acoustic Noise Reduction

Troublesome acoustic noise at audible frequencies is reduced by having a distributed gap structure where the resin replaces the air gap. This enables a large reduction of acoustic noise compared to Ferrite Types.

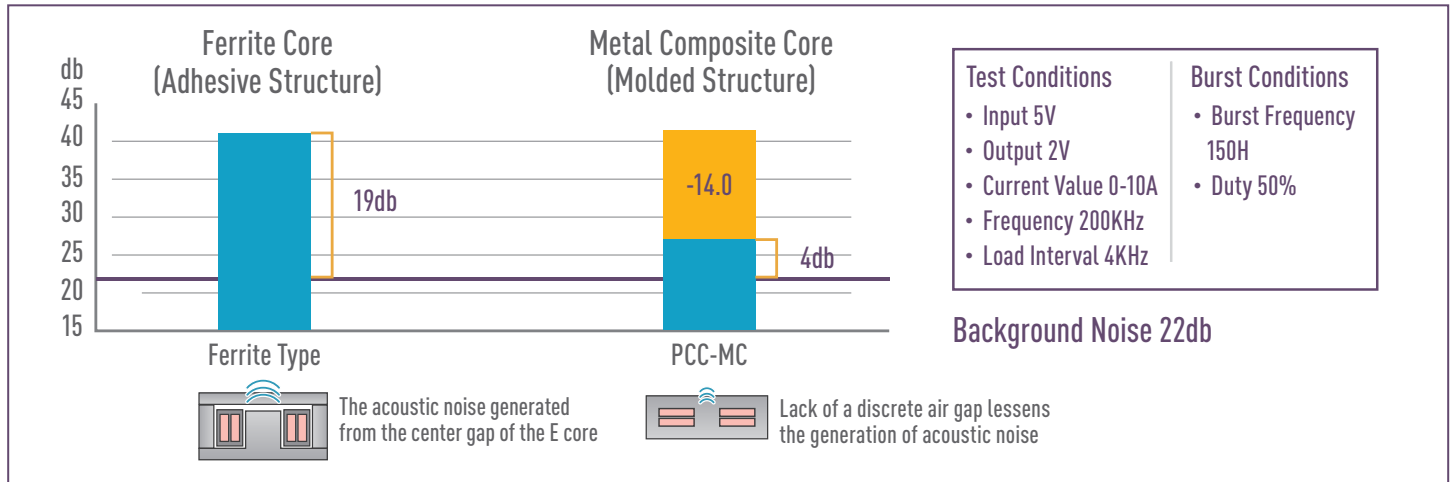

Excellent Withstanding Voltage Characteristics

ETQP Series Metal Composite Type achieves excellent withstanding voltage characteristics that can be used in various applications.

Rated Voltage Table															
Size mm \ Inductance uH	0.68	1	1.5	2.2	3.3	4.7	6.8	10	15	22	33	47	68	100	
12.6×12.8×8.0mm	50V														
10.9×10.0×6.0mm	70V				70V										
10.9×10.0×5.0mm	70V				70V										
10.7×10.0×5.4mm							70V					65V	45V		
8.5×8.0×5.4mm							60V					65V	45V		
7.5×7.0×5.4mm							50V						25V		
6.5×6.0×4.5mm				40V			35V					25V			
6.5×6.0×3.0mm	40V						35V								
5.5×5.0×4.0mm						40V	35V								
5.5×5.0×3.0mm				40V	35V										

Panasonic's ETQP Series Part Number Breakdown

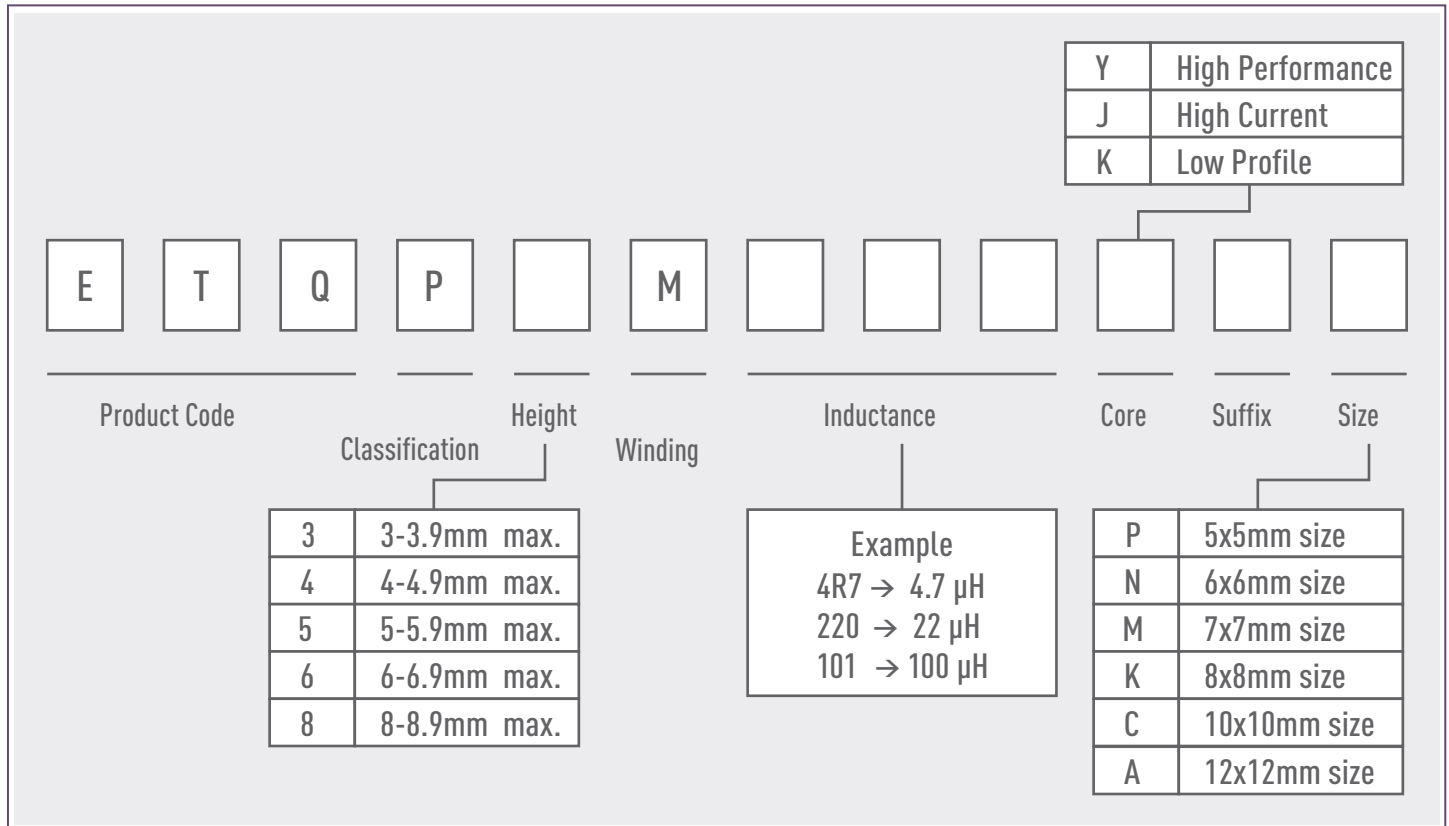

Panasonic's ETQP Series Vs. Alternative Products

With unique metal magnetic material technology, the ETQP Series displays low loss and downsizing compared with alternative products.

Panasonic Vs. Alternative Products

	22 μ H			47 μ H		
Manufacturer	Panasonic		Alternative Products	Panasonic		Alternative Products
Power Inductor	8 × 8.5 × 5.4 ETQP5M220YFK	10 × 10.7 × 5.4 ETQP5M220YFC	10 × 10.7 × 4.0 22 μ H	8 × 8.5 × 5.4 ETQP5M470YFK	10 × 10.7 × 5.4 ETQP5M470YFC	10 × 10.7 × 4.0 47 μ H
Frequency	400kHz	400kHz	400kHz	400kHz	400kHz	400kHz
DCR 20°C	63m Ω	45m Ω	70m Ω	125m Ω	96m Ω	165m Ω
ACR	1190m Ω	861m Ω	1254m Ω	2416m Ω	2171m Ω	2805m Ω
Rated Current	4.33A	4.33A	4.33A	2.47A	2.47A	2.47A
I _{ac} (Ripple)	1.11A	1.11A	1.11A	0.52A	0.52A	0.52A
I _{dc} RMS	4.42A	4.42A	4.42A	2.51A	2.51A	2.51A
I _{ac} RMS	0.64A	0.64A	0.64A	0.30A	0.30A	0.30A
DC Loss	1.65W	1.18W	1.83W	1.06W	0.81W	1.39W
AC Loss	0.46W	0.34W	0.52W	0.22W	0.20W	0.25W
Total Loss	2.11W	1.51W	2.35W	1.27W	1.01W	1.65W
ΔT (Top)	78.1K	49.9K	80.9K	47.1K	33.2K	56.8K
ΔT (Terminal)	58.0K	35.5K	58.6K	35.0K	23.6K	41.1K

Panasonic's ETQP Series Selection Guide

High Performance Series												
Type	5x5 ETQP*MxxxYFP		6x6 ETQP*MxxxYFN		7x7 ETQP5MxxxYFM		8x8 ETQP*MxxxY*K		10x10 ETQP*MxxxY*C		10x10 (Low DCR) ETQP*MxxxYLC	
(Size) WxLxT Height=t	5.5x5.0mm t=3.0mm (<4.7μH) t=4.0mm (≥4.7μH)		6.5x6.0mm t=3.0mm (<6.8μH) t=4.5mm (≥6.8μH)		7.5x7.0mm t=5.4mm (<95μH) t=5.0mm (≥95μH)		8.5x8.0mm t=5.4mm (<95μH) t=5.0mm (≥95μH)		10.7x10.0mm t=5.4mm (<95μH) t=5.0mm (≥95μH)		10.9x10.0mm t=5.0mm (<1.5μH) t=6.0mm (≥1.5μH)	
LO (μH)	Rated Current (A)	DCR (mOhm)	Rated Current (A)	DCR (mOhm)	Rated Current (A)	DCR (mOhm)	Rated Current (A)	DCR (mOhm)	Rated Current (A)	DCR (mOhm)	Rated Current (A)	DCR (mOhm)
100					1.4(*1)	348	1.7	302	1.6(*2)	208		
68									3.0(*7)	136		
47			1.8	210	2.3 (*3)	156	2.9 (*3)	125	3.5	99		
33			2.0	172	2.6	120			4.2	68.5		
22	1.9	163	2.3	126	3.0	92.0	4.1	63.0	5.2(*5)	45.0		
15							4.7	48.2				
10			3.3	54.2	4.7	37.6	5.7	33	7.1	23.8		
6.8			4.1	39.3	5.5	26.7						
4.7	4.0	36.0			6.3	20			10.9	10.2	11.8	8.7
3.3	4.1	31.3							13.1	7.1	14.2 (*6)	6.0
2.2	4.8	22.6					11.9 (*4)	7.6	15.1(*4)	5.3	16.3 (*4)	4.55
1.5									17.9	3.8	19.5	3.2
1.0			8.8	7.9							23.0	2.3
0.68			9.8	6.3							26.3	1.75

*please contact Panasonic for availability

Note: Current value (Rated Current) is the typical value when overall temperature rise is 40k

(*1) 95μH (*2) 97μH (*3) 48μH (*4) 2.5μH (*5) 21.5μH (*6) 3.2μH (*7) 66μH

Panasonic's ETQP Series Selection Guide

Low Profile Series // High Current Series

Type	5x5 ETQP*MxxxKVP		6x6 ETQP*MxxxKVN		8x8 ETQP*MxxxKVK		10x10 ETQP*MxxxKVC		12x12 ETQP*MxxxJFA	
(Size) WxLxT Height=t	5.5x5.0mm t=3.0mm		6.5x6.0mm t=3.0mm		8.5x8.0 t=4.0mm		10.7x10.0mm t=4.0mm		12.6x13.2mm t=8.0mm	
LO (μH)	Rated Current (A)	DCR (mOhm)	Rated Current (A)	DCR (mOhm)	Rated Current (A)	DCR (mOhm)	Rated Current (A)	DCR (mOhm)	Rated Current (A)	DCR (mOhm)
47							2.8	132.0		
33			1.7	207	2.6	118	3.4	84.6		
22			2.2	128	3.3	76.3	4.1	60.0		
15			2.5	99.2	3.8	55	5.2	37.0		
10	2.4	96	2.9	71.0	4.4	41.6	6.3	25.4		
6.8	2.9	65.7	3.6	45.6	5.9	23.5	7.4	18.5		
4.7	3.4	45.6	4.6	29.0	7.1	16.1	9.2	11.8	16.8	4.9
3.3	4.4	27.3	5.0	24.1	7.6	14	10.3	9.4	19.6(*1)	3.6
2.2	5.2	20.0	6.5	14.5	9.8	8.5	12.1	6.8	23.0	2.6
1.5	6.7	12.0	7.4	11.0	12.8	4.9	14.3	4.0	27.7	1.8
1.0	7.5	9.6	9.9	6.2	14.8	3.7	19.6	2.6	31.8	1.36
0.68	8.4	7.6	10.8	5.2	16.7	2.9			35.4	1.1
0.33									44.4	0.7

*please contact Panasonic for availability

Note: Current value (Rated Current) is the typical value when overall temperature rise is 40k
(*1) 2.5μH

Panasonic offers for its Power Inductor portfolio a device library for circuit simulators, CAD data as well as many other additional information that help design circuits more efficiently. For further information please refer to the related data as it is listed under the QR code.

Simulation Data Libraries	Industrial & Automotive Use LC Filter Simulator	Power Inductor Loss Simulator	CAD Data
Equivalent circuit models and S-parameter data can be downloaded for each individual item number.	The Industrial & Automotive use LC filter simulator enables the simulation of attenuation amounts when configuring a filter using Panasonic's power inductor and aluminium electrolytic capacitor suitable for industrial & automotive use.	The Power Inductor loss simulator for automotive application enables the simulation of losses and temperature rises according to the current for Panasonic's power inductors designed for automotive use.	CAD data can be download. (3D STEP, 3D PDF)

Characteristic Viewer
Characteristic Viewer is the tool which represent various characteristics of a selected part by means of a graph of the frequency axis and temperature axis, etc.

Local Technical Support	Sample Support
Our Business Development Team as well as our respective Product Manager are available for technical on-site support.	For sample support, please contact Panasonic Industry Europe directly.

